

ROUTER BITS FOR WORKING ON SOLID SURFACE MATERIALS

The series of tools on page 3.05 to page 3.13 have been specifically designed for working Solid Surface materials (**CORIAN®**). The type of raw material, cutting angles and components used in manufacturing the router bits shown here have been carefully selected to get the best finishing. Special router bits can be manufactured on request.



HW ROUTER BITS WITH NEGATIVE AXIAL ANGLE Z=2

ART. E300 - G300

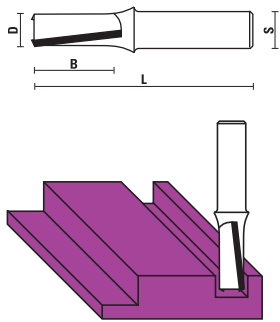

S Ø 12	S Ø 12,7 (1/2")	D	B	L
E300.095.R	G300.095.R	9,5	50	70
E300.127.R	G300.127.R	12,7	32	73
E300.128.R	G300.128.R	12,7	38	79
E300.129.R	G300.129.R	12,7	50	107,5

HW STRAIGHT PLUNGE BITS Z=1

ART. E301 - G301

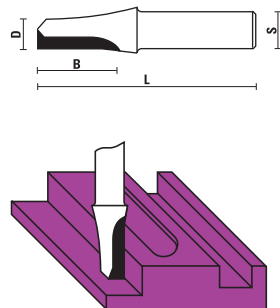

S Ø 12	S Ø 12,7 (1/2")	D	B	L
E301.095.R	G301.095.R	9,5	25	70

HW STRAIGHT PLUNGE BITS WITH BALL BEARING GUIDE Z=2

ART. E302 - G302

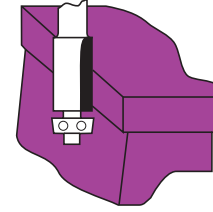
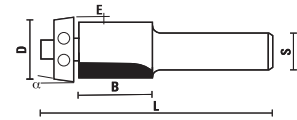

5° ball bearing with Delrin® ring

S Ø 12	S Ø 12,7 (1/2")	D	B	α	E	L
E302.190.R	G302.190.R	19	25	5°	1,6	82,5



S Ø 12	S Ø 12,7 (1/2")	D	B	L	α
E302.191.R	G302.191.R	19	25,4	80	0°



HW FACE-INLAY BITS WITH BALL BEARING GUIDE Z=2

ART. E305 - GE306 - E307

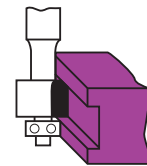
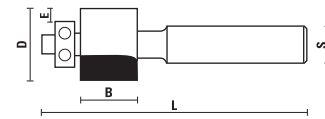

S Ø 12	D	B	L	E	
E305.064.R	Selling out	22	6,4	76	4,8
E305.095.R	Selling out	22	9,5	78	4,8
E305.127.R		22	12,7	82	4,8
E305.190.R	Selling out	22	19	88	4,8



S Ø 12	D	B	L	E	
E306.064.R		22	6,4	76	3,2
E306.095.R		22	9,5	78	3,2
E306.127.R		22	12,7	82	3,2
E306.190.R		22	19	88	3,2



S Ø 12	D	B	L	E	
E307.095.R		22	9,5	79	1,6
E307.127.R		22	12,7	82	1,6
E307.190.R		22	19	82	1,6



HW FLUSH TRIM BITS WITH BALL BEARING GUIDE Z=2

ART. E310 - G310

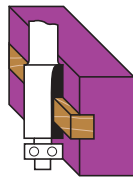
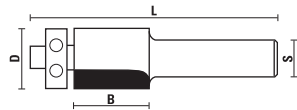

S Ø 12	S Ø 12,7 (1/2")	D	B	L
E310.190.R	G310.190.R	19	25	82



Z050.101.N



Z053.002.N



Z051.004.R

HW FLUSH TRIM BITS WITH UPPER BALL BEARING GUIDE Z=2

ART. E312 - G312

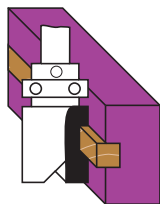
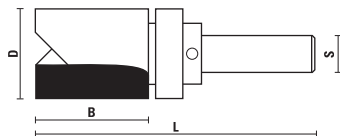

S Ø 12	S Ø 12,7 (1/2")	D	B	L
E312.286.R	G312.286.R	28,6	38	92



Z050.015.N



Z058.003.N



Z051.005.R

HW TOPMOUNT ROUTER BITS Z=2

ART. E315

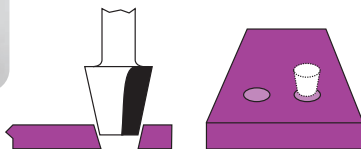
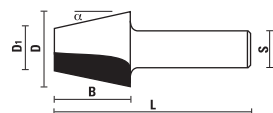

S Ø 12	D	D ₁	B	L	α
E315.240.R	23	12,3	25	63,1	15°
E315.340.R	34	23,3	25	63,1	15°
E315.450.R	45	34,3	25	63,1	15°

HW BEVEL HOLE ROUTER BITS Z=3

ART. E315

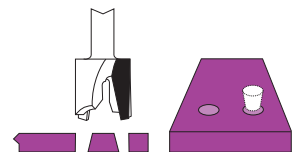
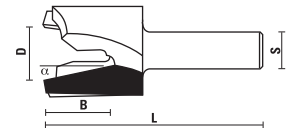

S Ø 12	D	B	L	α
E315.730.R	23	20	72	15°
E315.840.R	34	20	72	15°
E315.950.R	45	20	72	15°

HW BEVEL UNDERMOUNT BITS WITH BALL BEARING GUIDE Z=2

ART. E316 - G316

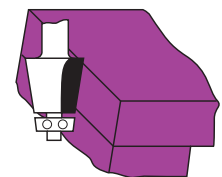
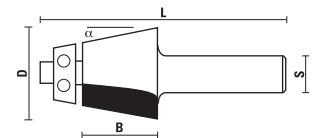

12° ball bearing with Delrin® ring

S Ø 12	S Ø 12,7 (1/2")	D	B	L	α
E316.320.R	G316.320.R	32	25	81	12°



Z050.102.N



Z053.002.N



Z051.004.R

S Ø 12	S Ø 12,7 (1/2")	D	B	L	α
E316.390.R	G316.390.R	39	32	78	12°



Z050.106.N



Z053.002.N



Z051.007.R

HW TOPMOUNT COUNTERTOP BITS WITH UPPER BALL BEARING GUIDE Z=2

ART. E317 - G317

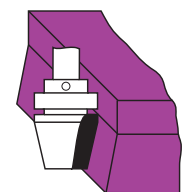
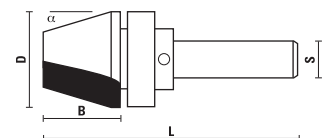

S Ø 12	S Ø 12,7 (1/2")	D	B	L	α
E317.286.R	G317.286.R	28,6	25	78	12°



Z050.015.N



Z058.003.N



Z051.005.R

HW TOPMOUNT COUNTERTOP BITS WITH UPPER BALL BEARING GUIDE Z=2

ART. E321

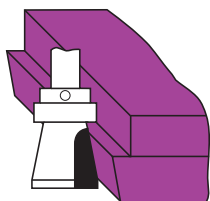
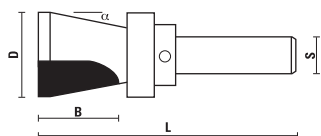

S Ø 12	D	B	L	α
E321.286.R	28,6	26	79	12°



Z050.015.N



Z058.003.N



Z051.005.R

HW ROUNDROVER BITS WITH BALL BEARING GUIDE Z=2

ART. E325 - G325

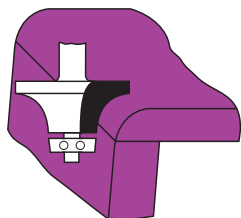
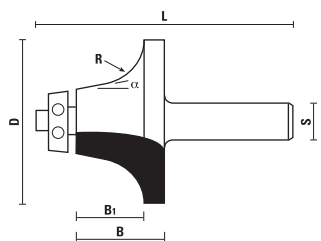

18° ball bearing with Delrin® ring

S Ø 12	S Ø 12,7 (1/2")	D	B	B1	L	R	α
E325.540.R	G325.540.R	54	25	19	79	12,7	18°
E325.570.R	G325.570.R	57	32	25	83	14	18°



Z050.102.N



Z053.002.N



Z051.004.R

HW OGEE BITS WITH BALL BEARING GUIDE Z=2

ART. E326 - G326

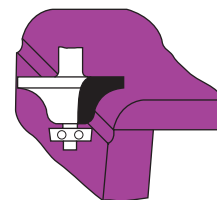
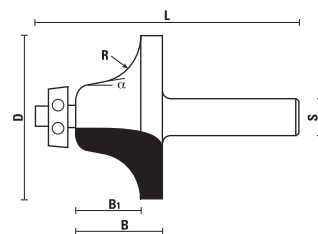

15° ball bearing with Delrin® ring

S Ø 12	S Ø 12,7 (1/2")	D	B	B1	L	R	α
E326.550.R	G326.550.R	55	25	19	75	12,7	15°
E326.610.R		61	32	25	86	14	15°



Z050.102.N



Z053.002.N



Z051.004.R

HW COUNTER-TOP BITS WITH BALL BEARING GUIDE Z=2

ART. E330 - G330

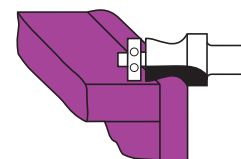
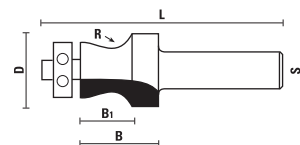

For anti-drip profile on washbasin

S Ø 12	S Ø 12,7 (1/2")	D	B	B1	L	R
E330.220.R	G330.220.R	25	22	16	79	8
E330.290.R	G330.290.R	25	29	24	85	8



Z050.101.N



Z053.002.N



Z051.004.R

HW CORNER TOP BITS Z=2

ART. E333 - G333

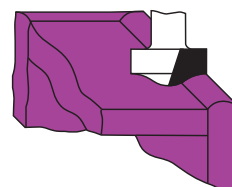
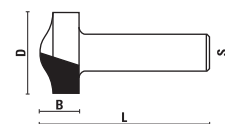

S Ø 12	S Ø 12,7 (1/2")	D	B	L
E333.254.R	G333.254.R	25,4	13	54

HW CORNER ROUNDING BITS WITH BALL BEARING GUIDE Z=2

ART. E334 - G334

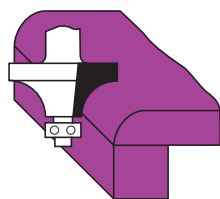
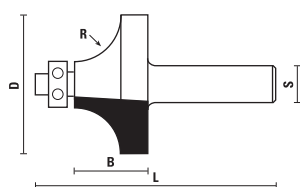
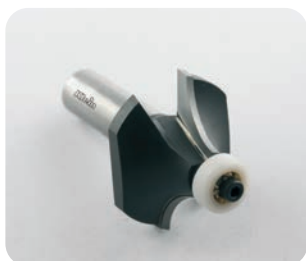

S Ø 12	S Ø 12,7 (1/2")	D	B	L	R
E334.254.R	G334.254.R	25,4	13	62	6,4
E334.286.R	G334.286.R	28,6	13,5	61	8
E334.380.R	G334.380.R	38	19	65	12,7
E334.510.R	G334.510.R	51	25	72	19



Z050.100.N



Z053.002.N



Z051.002.R

HW ROUNDING-UNDER BITS WITH UPPER BALL BEARING GUIDE Z=2

ART. E335 - G335

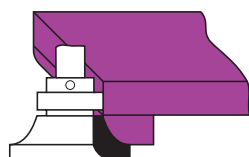
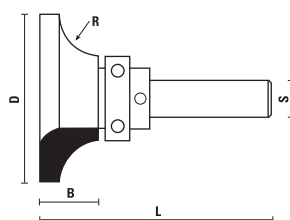

For bottom rounding

S Ø 12	S Ø 12,7 (1/2")	D	B	L	R
E335.540.R	G335.540.R	54	20	73	12,7
E335.670.R*	G335.670.R	67	25	77	19

*Selling out



Z050.104.N



Z058.003.N



Z051.005.R

HW CORNER-ROUNDING BITS WITH BALL BEARING GUIDE Z=2

ART. E336 - G336

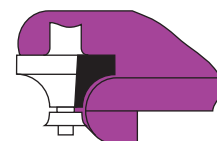
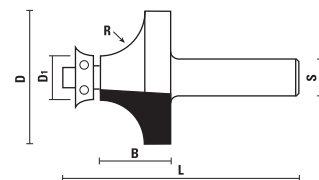
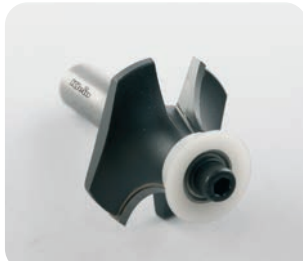

R=12,7 ball bearing

S Ø 12	S Ø 12,7 (1/2")	D	D1	R	B	L
E336.410.R	G336.410.R	41	16	13	19	68



Z050.105.N



Z053.002.N



Z051.004.R

S Ø 12	S Ø 12,7 (1/2")	D	D1	R	B	L
E336.540.R	G336.540.R	54	16	19	25	74



Z050.113.N



Z053.002.N



Z051.004.R

HW EDGE FACE COVE BITS WITH BALL BEARING GUIDE Z=2

ART. E338

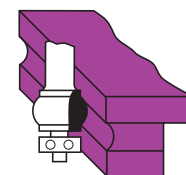
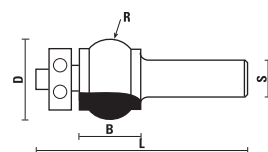

S Ø 12	D	B	L	R	
E338.255.R	Selling out	25,5	16	67	7,9



Z050.101.N



Z053.002.N



Z051.004.R

HW UPSTAND BITS Z=2

ART. E340 - G340

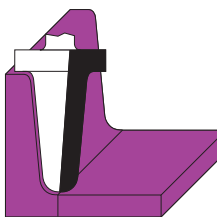
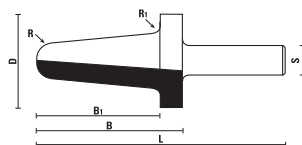

S Ø 12	S Ø 12,7 (1/2")	D	B	B1	R	R1	L
E340.390.R*		39	40	30	6	3	78
E340.391.R	G340.391.R	39	55	45	6	3	93

*Selling out

HW COVE BITS WITH UPPER BALL BEARING GUIDE Z=2

ART. E342 - G342

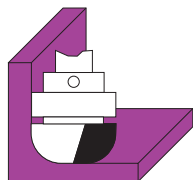
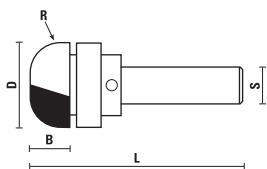

S Ø 12	S Ø 12,7 (1/2")	D	B	R	L
E342.286.R	G342.286.R	28,6	13	10	73



Z050.104.N



Z058.003.N



Z051.005.R

HW BOWL AND COUNTERTOP TRIM BITS Z=2

ART. E350 - G350

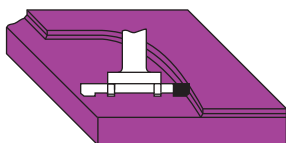
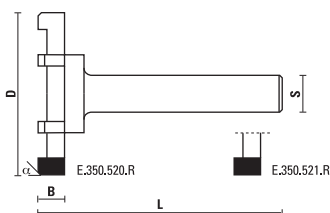

S Ø 12	S Ø 12,7 (1/2")	D	B	L	Z	α
E350.520.R	G350.520.R	52	6,5	83	6	0,5x45°
E350.521.R	G350.521.R	52	6,5	83	6	0°

HW PROFILE BITS Z=2

ART. E360

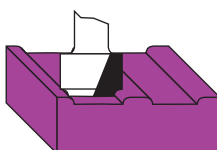
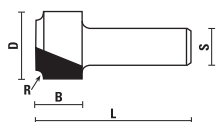

S Ø 12	D	B	R	L
E360.246.R	24,6	16	2	60

HW PROFILE BITS Z=2

ART. E361

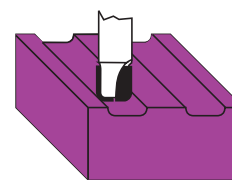
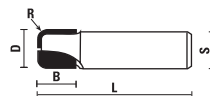

S Ø 12	D	B	R	L
E361.127.R	12,7	13	3,2	51
E361.160.R	16	13	3,2	51
E361.190.R	19	13	3,2	51
E361.254.R	25,4	13	3,2	51

HW UNDERMOUNT PROFILE BOWL BITS WITH BALL BEARING GUIDE Z=2

ART. E362

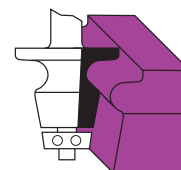
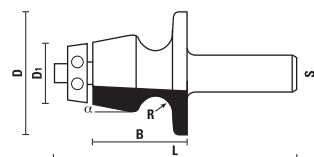

10° ball bearing with Delrin® ring

S Ø 12	D	D1	B	R	L	α
E362.420.R	42	22	33	6,4	84	10°



Z050.102.N



Z053.002.N



Z051.004.R

HW BEVEL HOB BITS WITH BALL BEARING GUIDE Z=2

ART. E363

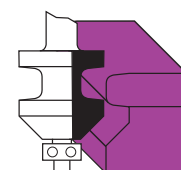
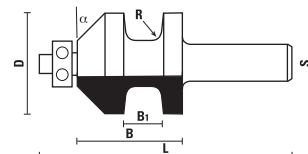

S Ø 12	D	B	B1	R	L	α
E363.350.R	35	36,5	12-13	3,2	89	45°



Z050.011.N



Z054.003.N



Z051.004.R

HW BEADING BITS Z=2

ART. E364

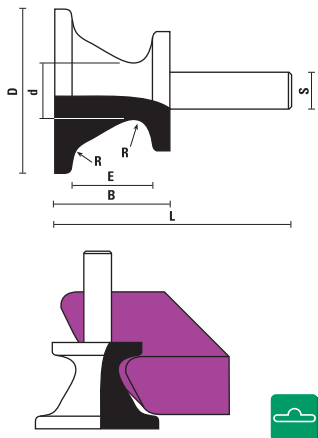



S Ø 12	D	d	B	E	R	L
E364.370.R Selling out	37	16	25	12-13	4,8	84
E364.540.R Selling out	54	19	37	24-26	6,4	96
E364.710.R Selling out	71	22	50	36-39	9,5	109

HW TRIPLE BEADING BITS WITH BALL BEARING GUIDE Z=2

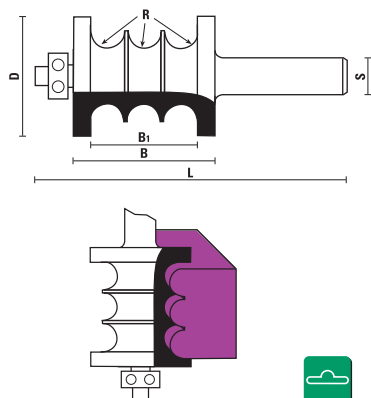
ART. E365



S Ø 12	D	B	B1	R	L
E365.410.R Selling out	41	51	39	6	101



 Z050.011.N
  Z053.002.N
  Z051.004.R

HW DOUBLE BEADING BITS WITH BALL BEARING GUIDE Z=2

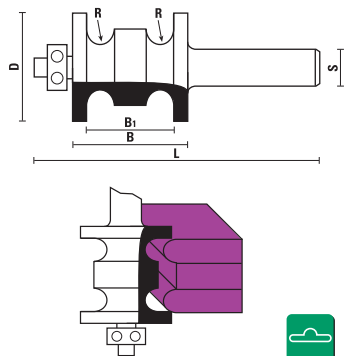
ART. E366



S Ø 12	D	B	B1	R	L
E366.380.R Selling out	38	51	38	6	79



 Z050.011.N
  Z054.003.N
  Z051.004.R

HW MULTI BEADING BITS WITH BALL BEARING GUIDE Z=2

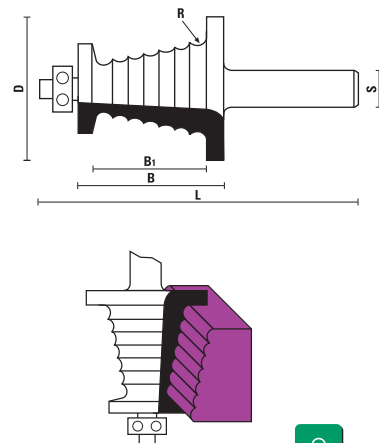
ART. E367



S Ø 12	D	B	B1	R	L
E367.510.R Selling out	51	51	38	3	99



 Z050.011.N
  Z053.002.N
  Z051.002.R

HW EDGE Moulding BITS WITH BALL BEARING GUIDE Z=2

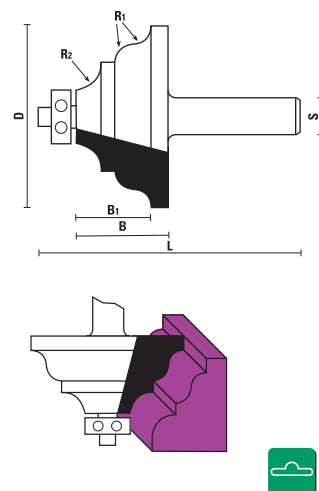
ART. E368



S Ø 12	D	B	B1	R1	R2	L
E368.635.R Selling out	63,5	32	27	6,4	9,5	81

 Z050.011.N
  Z053.002.N
  Z051.004.R

HW EDGE MOULDING BITS WITH BALL BEARING GUIDE Z=2

ART. E370

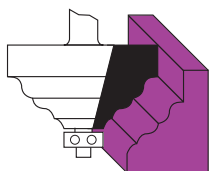
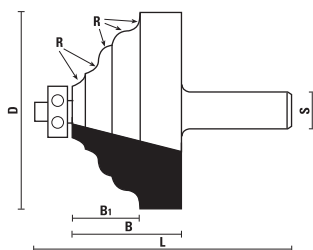

S Ø 12	D	B	B1	R	L
E370.700.R Selling out	70	40	33	4,8	87



Z050.101.N



Z053.002.N



Z051.004.R

HW WAVY EDGE BITS WITH BALL BEARING GUIDE Z=2

ART. E371

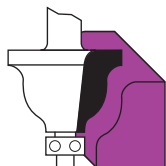
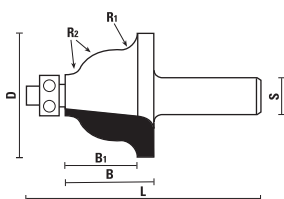

S Ø 12	D	B	B1	R1	R2	L
E371.440.R Selling out	44	32	25	6	13	82,5



Z050.100.N



Z053.002.N



Z051.002.R

HW EDGE MOULDING BITS WITH BALL BEARING GUIDE Z=2

ART. E373

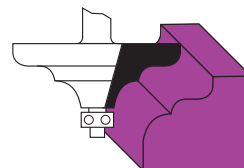
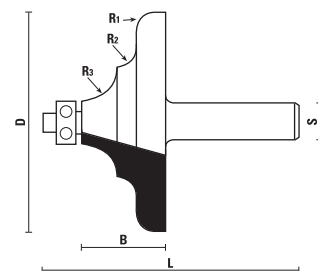

S Ø 12	D	R1	R2	R3	B	L
E373.760.R Selling out	76	6,4	6	12,7	30	78



Z050.100.N



Z053.002.N



Z051.002.R

HW EDGE MOULDING BITS WITH BALL BEARING GUIDE Z=2

ART. E374

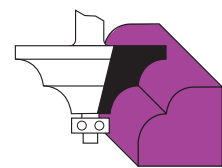
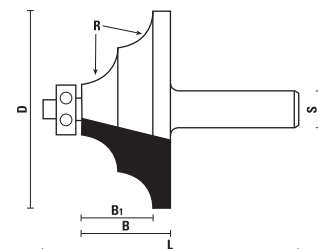

S Ø 12	D	B	B1	R	L
E374.700.R Selling out	70	32	25	12,7	82,5



Z050.101.N



Z053.002.N



Z051.004.R

HW ROMAN OGEE BITS WITH BALL BEARING GUIDE Z=2

ART. E375

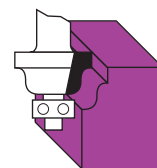
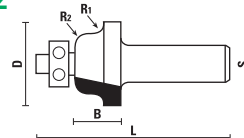

S Ø 12	D	B	R1	R2	L
E375.286.R	28,6	16	3,2	4	63,5



Z050.100.N



Z053.002.N



Z051.002.R

HW EDGE MOULDING BITS WITH BALL BEARING GUIDE Z=2

ART. E376

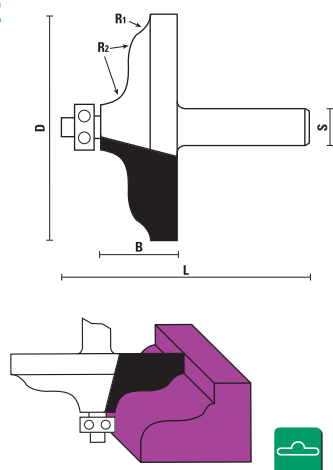

S Ø 12	D	B	R1	R2	L
E376.790.R Selling out	79	28	5,2	9	74,5



HW EDGE MOULDING BITS WITH BALL BEARING GUIDE Z=2

ART. E377

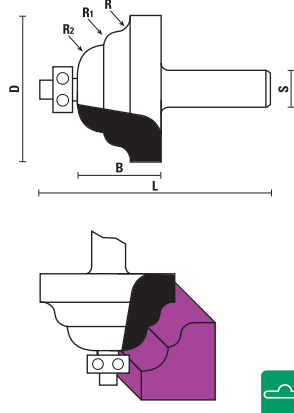

S Ø 12	D	R	R1	R2	B	L
E377.510.R Selling out	51	4,4	4,4	9,5	28	82,5



HW EDGE MOULDING BITS WITH BALL BEARING GUIDE Z=2

ART. E378

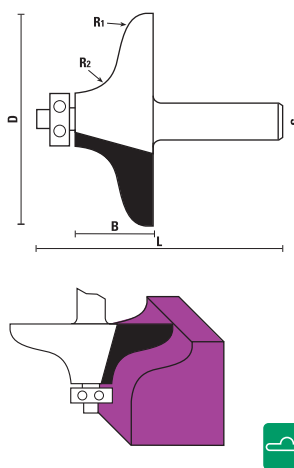

S Ø 12	D	B	R1	R2	L
E378.760.R Selling out	76	28	8	12,7	79



HW BEVEL BITS WITH BALL BEARING GUIDE Z=2

ART. E380 - G380

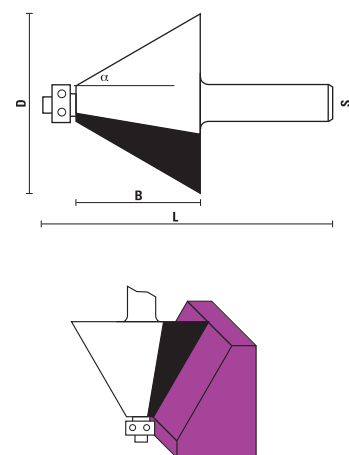
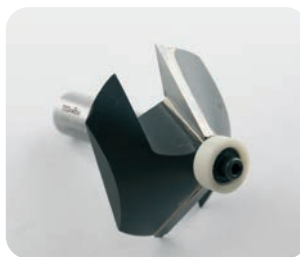

S Ø 12	S Ø 12,7 (1/2")	D	B	L	α
E380.510.R	G380.510.R	51	19	67	45°
E380.640.R	G380.640.R	64	44	93	30°



HW EDGE MOULDING BITS WITH BALL BEARING GUIDE Z=2

ART. E381

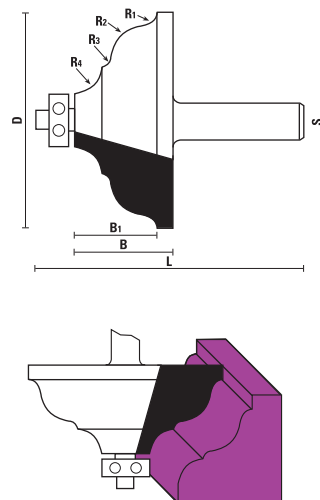

S Ø 12	D	B	B1	R1	R2	R3	R4	L
E381.760.R Selling out	76	34,9	29	4,8	12,7	3,2	9,5	84



HW CIRCULAR SAWBLADES

ART. MES

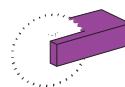

See also Art. MES section 12 page 12.34

HW ROUTER BITS FOR SINK REPAIRING

ART. E382 - G382

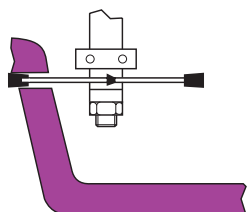
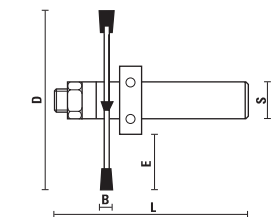

S Ø 12	S Ø 12,7 (1/2")	D	E	B	L	Z
E382.670.R	G382.670.R	80	25,7	6	96	4

Spare parts

Spare arbor

E117.120.N

Spare cutter D= Ø 80/Ø 8 Z=4

C118.980.R



Z050.112.N

HW ROUNDING OVER UNDERMOUNT BOWL BITS WITH BALL BEARING GUIDE Z=2

ART. E383 - G383

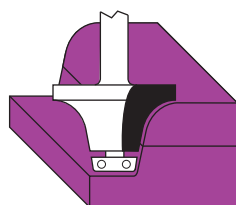
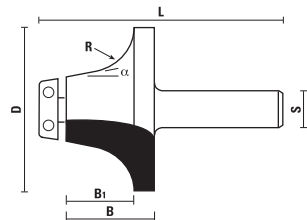
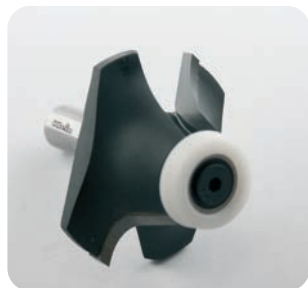

17° ball bearing with Delrin® ring

S Ø 12	S Ø 12,7 (1/2")	D	B	B1	R	L	α
E383.450.R	G383.450.R	45	17,5	13,5	9,5	63,5	17°
E383.510.R	G383.510.R	51	17,5	13,5	12,7	63,5	17°
E383.540.R	G383.540.R	54	25	20	12,7	73	17°
E383.570.R	G383.570.R	57	25	20	19	76	17°



Z050.120.N

HW ROUNDING OVER UNDERMOUNT BOWL BITS WITH BALL BEARING GUIDE Z=2

ART. E384

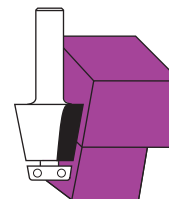
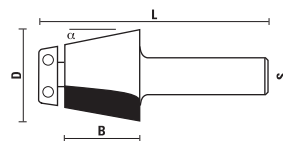

12° ball bearing with Delrin® ring

S Ø 12	D	B	L	α
E384.320.R	32	25	76	12°



Z050.102.N

INSERT FLUSH TRIM BITS Z=2

ART. W138

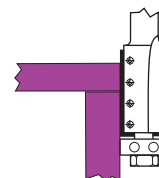
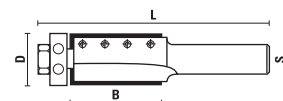

- HW knives with "Kawedur" coating
- For CORIAN®
- Ball bearing with Delrin® ring

S Ø 12	D	B	L
W138.190.R	19	30	82



Z050.111.N



Z055.230.N



Z051.101.N

INSERT FLUSH TRIM BITS Z=2

ART. W138

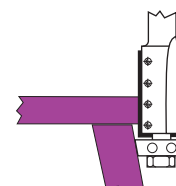
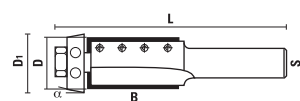

- HW knives with "Kawedur" coating
- For CORIAN®
- 11° ball bearing with Delrin® ring

S Ø 12	D	D1	B	L	α
W138.220.R	19	22	30	82	11°



Z050.110.N



Z055.230.N



Z051.101.N

See also section 9 page 9.07 for more details

HW/HS STRAIGHT PLUNGE CUTTING BITS FOR "ELU" Z=2

ART. F101 - F202

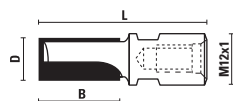

S = M12x1	D	B	L	Mat.
F101.060.R	6	18	60	HW
F101.070.R	7	20	60	HW
F101.080.R	8	25	60	HW
F101.100.R	10	25	60	HW
F101.120.R	12	25	60	HW
F101.140.R	14	25	60	HW
F101.150.R	15	25	60	HW
F101.160.R	16	25	60	HW
F101.180.R	18	25	60	HW
F101.200.R	20	25	60	HW
F101.220.R	22	25	60	HW
F101.240.R	24	25	60	HW
F101.250.R	25	25	60	HW
F101.300.R	30	25	60	HW

HW STRAIGHT PLUNGE CUTTING BITS FOR "ELU" Z=2

ART. F103 - F104 - F105



Long execution

S = M12x1	D	B	L
F103.080.R	8	35	67
F103.100.R	10	35	67
F103.120.R	12	35	67
F103.140.R	14	35	67
F103.160.R	16	35	67
F103.180.R	18	35	67
F103.200.R	20	35	67
F103.220.R	22	35	67
F104.120.R	12	45	77
F104.150.R	15	45	77
F104.160.R	16	45	77
F104.161.R	16	50	82
F104.180.R	18	45	77
F104.200.R	20	45	77
F105.140.R	14	60	92
F105.160.R	16	60	92
F105.180.R	18	60	92
F105.200.R	20	60	92
F105.220.R	22	60	92

HW STRAIGHT PLUNGE CUTTING BITS FOR "SCHEER" Z=2

ART. F152 - F153

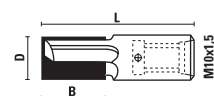

S = M10x1,5	D	B	L
F152.040.R	4	10	55
F152.050.R	5	12	55
F152.060.R	6	14	55
F152.080.R	8	20	55
F152.100.R	10	22	55
F152.120.R	12	22	55
F152.140.R	14	25	55
F152.150.R	15	25	55
F152.160.R	16	25	55
F152.180.R	18	25	55
F152.200.R	20	25	55
F152.220.R	22	25	55
F152.240.R	24	25	55
F152.250.R	25	25	55
F152.300.R	30	25	55

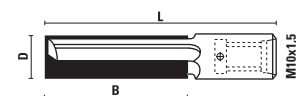

Long execution

S = M10x1,5	D	B	L
F153.060.R	6	30	65
F153.080.R	8	35	70
F153.100.R	10	35	70
F153.120.R	12	35	70
F153.140.R	14	35	70
F153.160.R	16	45	75
F153.180.R	18	45	75
F153.200.R	20	45	75
F153.220.R	22	45	75

HW DRILL BITS FOR "FESTOOL" MACHINES Z=2

ART. F160

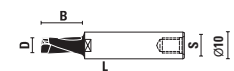

F160.040.R

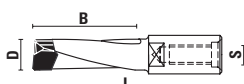

F160.050/100.R

- To be used on Festool® joining machines "Domino DF500"
- Suitable for creating dowel cross-cut for making "Domino" joints for frames, drawers, cabinets and furniture



S = M6x0,75	D	B	L
F160.040.R ▲ NEW	4	11	38
F160.050.R	5	20	49
F160.060.R	6	28	49
F160.080.R	8	28	49
F160.100.R	10	28	49

▲ Solid carbide

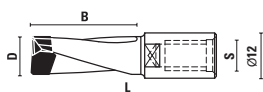

To be used on Festool® joining machines "Domino XL DF700"
Suitable for creating dowel cross-cut for making "Domino" joints for kitchen cabinets, tables and door frames



S = M8x1	D	B	L
F161.080.R NEW	8	50	90
F161.100.R NEW	10	70	90
F161.120.R NEW	12	70	90
F161.140.R NEW	14	70	90

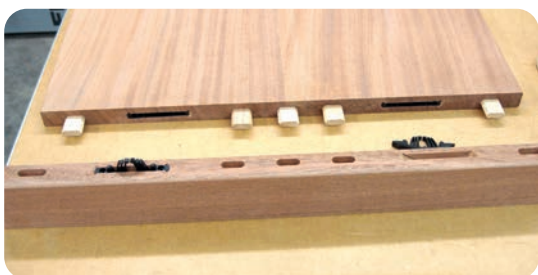

HW FLUSH TRIMMING BITS WITH BALL BEARING GUIDE Z=2

ART. F108

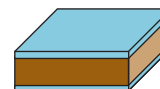
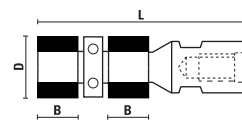

S = M12x1	D	B	L
F108.190.R	19	20	75



Z050.020.N

HW RADIUS BITS Z=2

ART. F110

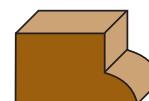
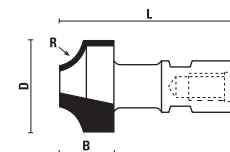

S = M12x1	D	R	B	L
F110.320.R selling out	32	10	15	60
F110.370.R selling out	37	12	18	60

HW RADIUS BITS WITH BALL BEARING GUIDE Z=2

ART. F111

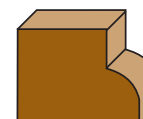
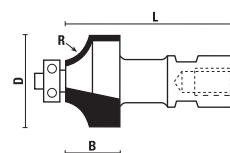

S = M12x1	D	R	B	L
F111.290.R	29	8	13	60
F111.330.R	33	10	15	60
F111.370.R	37	12	17	60
F111.430.R	43	15	20	60
F111.530.R	53	20	25	60

HW RADIUS BITS Z=2

ART. F112

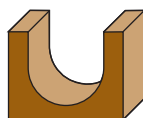
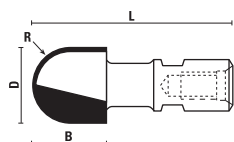

S = M12x1	D	R	B	L
F112.160.R	16	8	18	60
F112.200.R	20	10	18	60
F112.240.R	24	12	18	60
F112.300.R	30	15	18	60

HW RADIUS BITS Z=2

ART. F114

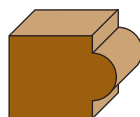
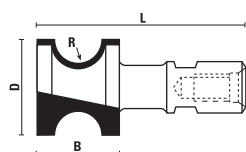

S = M12x1	D	R	B	L
F114.450.R	45	15	50	80

visit our website
www.sistemiklein.com



